

TOGIAN

COLLECTION RÉVÉLATION

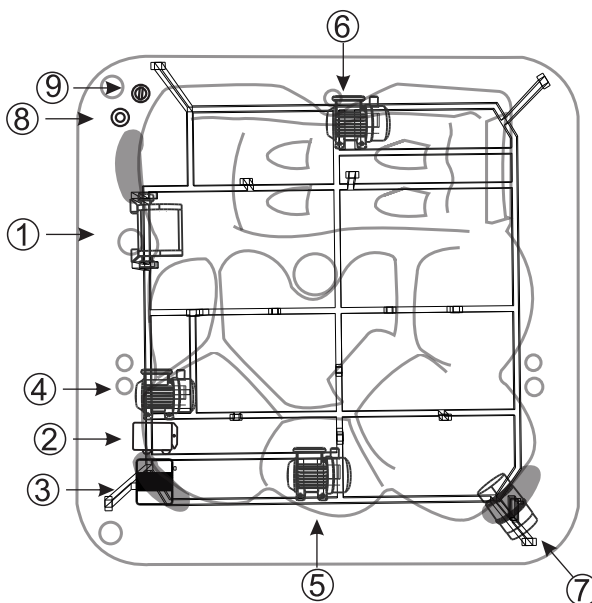

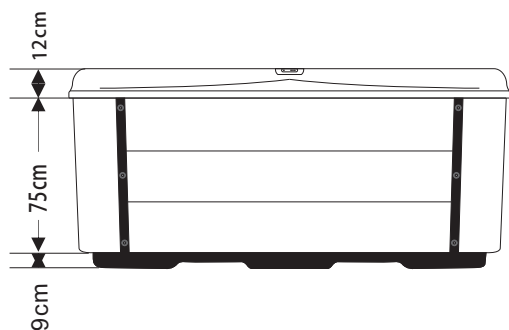

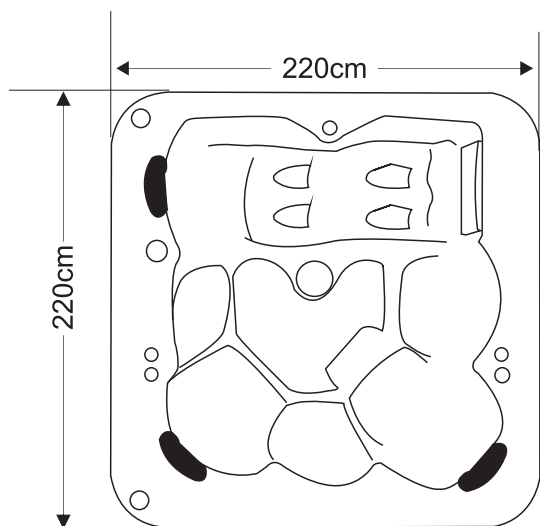



















1	Balboa System
2	LED Synchronizer(KLEDS-1)
3	Ozoner generator(KOZG-1)
4	LX Whirlpool Pump(LP 300)
5	LX Whirlpool Pump(Lp200)
6	LX Circulation Pump(WTC-50m)
7	Air Blower(APB400)
8	Cable
9	Drain

TOGIAN

COLLECTION RÉVÉLATION



- | | | |
|---|---|--|
|  KJ-50# |  KJ-7 |  Filter Cartridge |
|  KJ-2 |  Air Jet |  Waterfall |
|  KJ-2.5 |  Big LED |  Drain |
|  KJ-3.5 |  Air Valve |  Topside Panel |
|  KJ-3.5R |  Ozoner generator |  Diverter Valve |
|  KJ-4.5 |  Suction |  Pillow |
|  KJ-4.5R |  Outlet for circulate pump | |
|  KJ-5 |  Waterfall-control Valve | |