

DURANGO

COLLECTION RÉVÉLATION

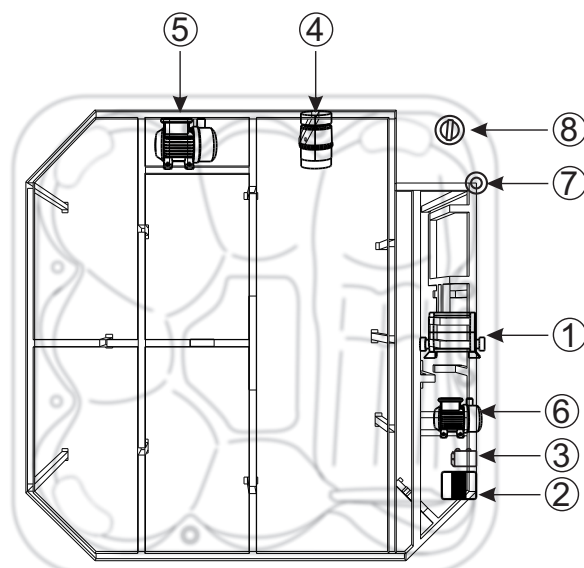

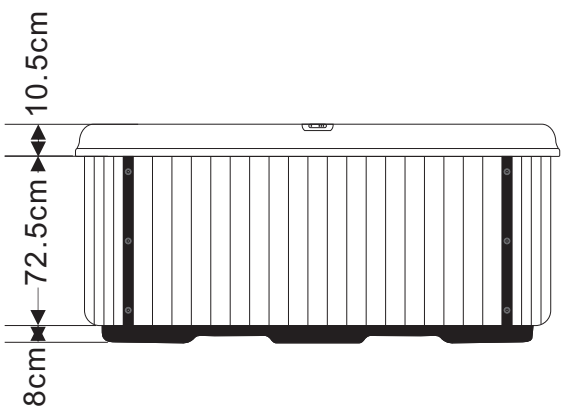

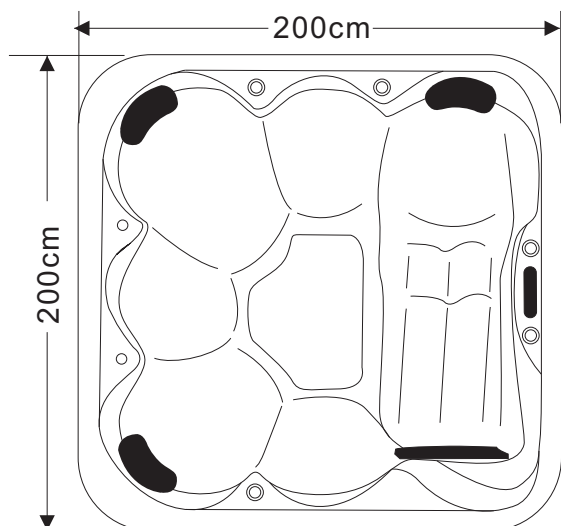















1	Balboa BP System
2	Ozoner Generator(KOZG-1)
3	LED Synchronizer(KLEDS-1)
4	Air Blower(APB400)
5	LX Whirlpool Pump(LP300)
6	LX Circulate Pump(WTC-50M)
7	Cable
8	Drain

DURANGO

COLLECTION RÉVÉLATION



- | | | | |
|---|----------------------------------|---|---------------------------|
|  | Diverter Valve |  | Big LED |
|  | Fountain/Waterfall-control Valve |  | Drain |
|  | Fountain |  | Ozoner |
|  | Suction |  | KJ-50# |
|  | Pillow |  | KJ-2 |
|  | Waterfall |  | KJ-2.5 |
|  | Air Jet |  | KJ-3.5 |
|  | Air Valve |  | KJ-3.5R |
|  | Filter Cartridge |  | Outlet for circulate pump |
|  | Topside Panel | | |