

















NOGALES

COLLECTION INSPIRATION



- | | | | |
|---|------------------------|---|--------------|
|  | Suction |  | KJ-50# |
|  | Air Jet |  | KJ-2.5 |
|  | Fountain |  | KJ-3.5R |
|  | Air Valve |  | KJ-3.5 |
|  | Pillow |  | KJ-5R |
|  | Big LED |  | KJ-5S |
|  | Fountain-control Valve |  | Drain |
|  | Diverter Valve |  | Ozoner mixer |
|  | Topside Panel | | |

NOGALES

COLLECTION INSPIRATION

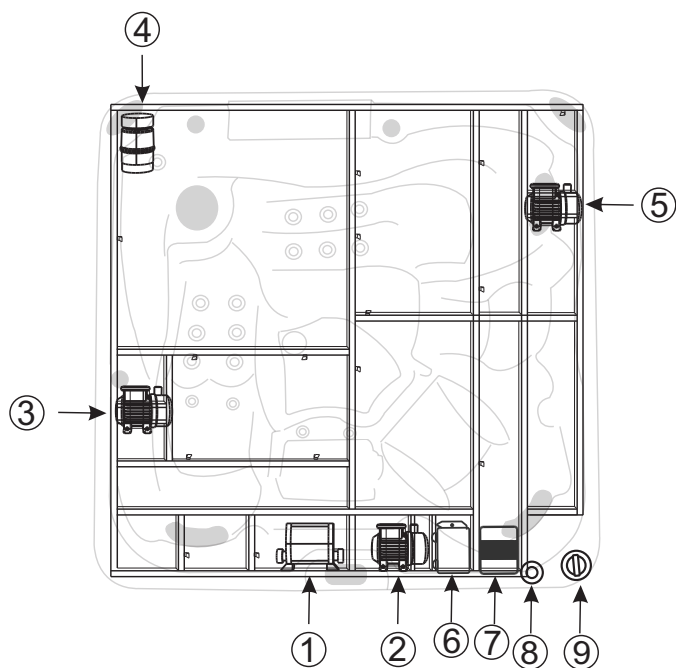
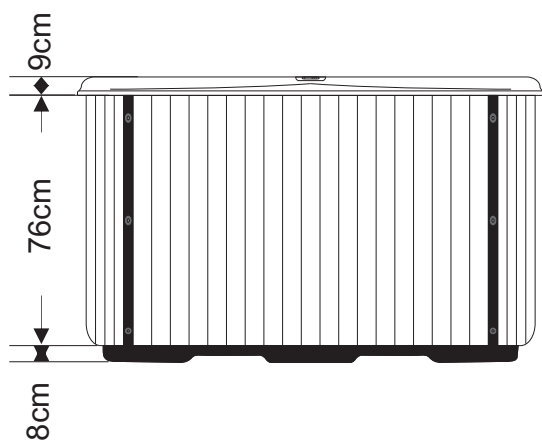
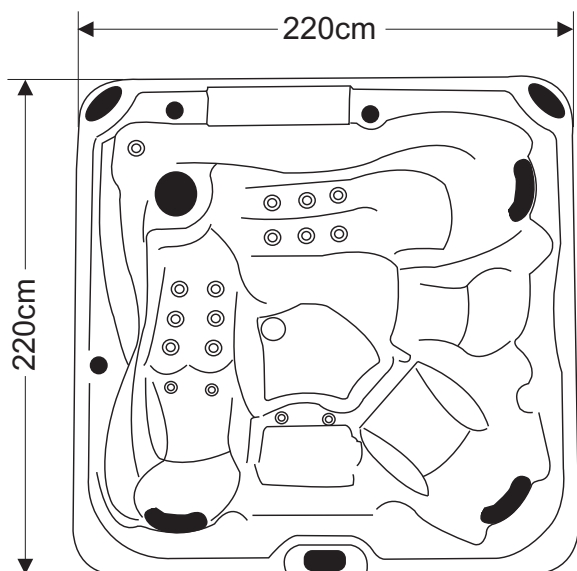

1	Balboa BP System
2	LX Whirlpool Pump(LP300)
3	LX Circulation Pump(WTC-50m)
4	LX Air Pump(400W)
5	LX Whirlpool Pump(LP200)
6	LED Synchronizer
7	Ozoner Generator
8	Cable
9	Drain