

# EVORA

COLLECTION SPA DE NAGE

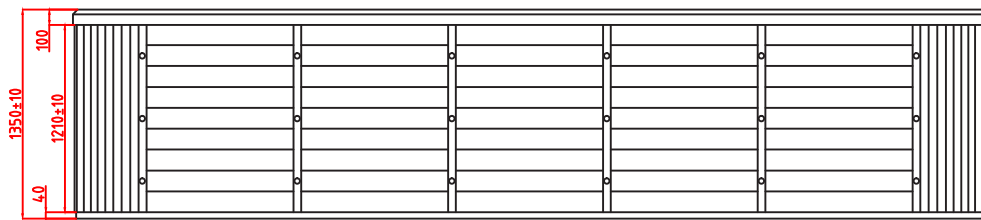

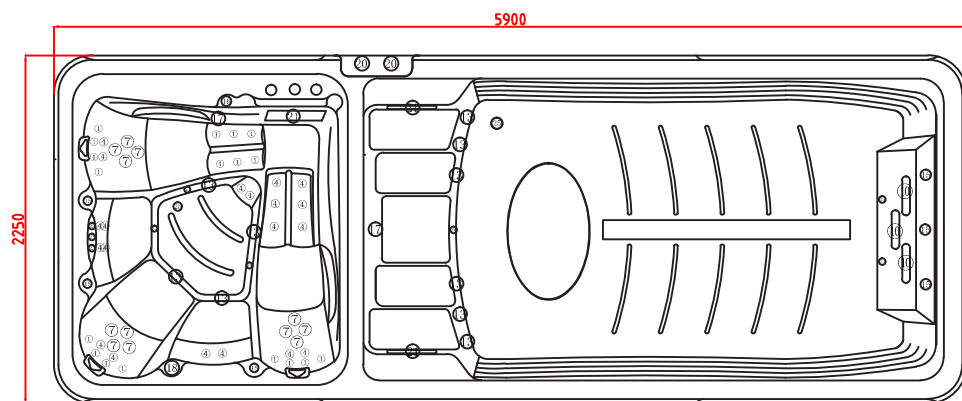

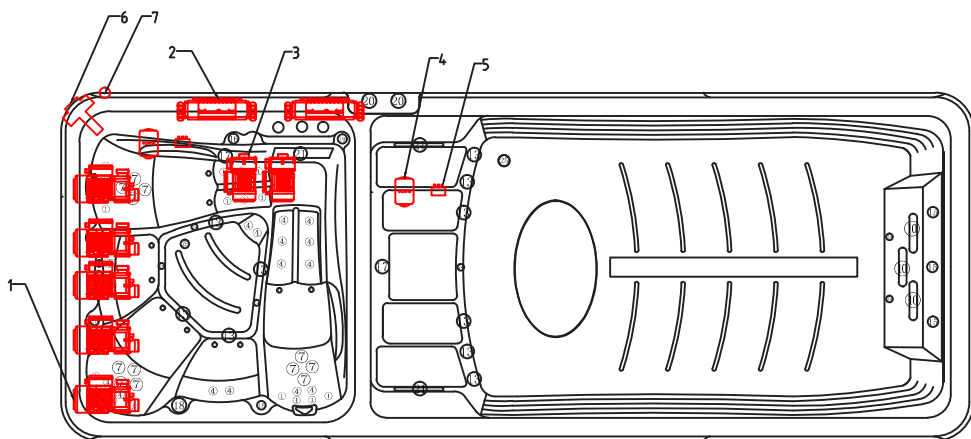













Item	name	hole size	number	Item	name	hole size	number
1	2 directional jet	Ø38	18	3	2.5 double roto jet	Ø40	20
7	3.5 double roto jet	Ø65	12	10	swirl jet	7	3
12	/	/	7	13	2000PM suction	Ø50	10
16	air regulator	Ø44	6	16	water controller	Ø50	1
17	LED light	Ø95	2	18	water diverter	Ø80	1
19	/	/	7	20	touch2 panel	By request	2
21	filter	/	3	23	water scope	Ø38	3
21	Circulating nozzle	Ø30	6	25	drain	Ø52	2



Item	name	number	Item	name	number
1	1.5 Whirlpool Pump (P300)	5	2	Balboa SP60/BC2 System	2
3	1.5 Circulate Pump (P350)	2	4	Booster Generator	2
5	LED Synchronization	2	6	Drain	1
7	Cable hole	1			

# PALAISSO

COLLECTION SPA DE NAGE

-  Diverter Valve
-  Fountain-control Valve
-  Air Valve
-  Suction
-  Big LED
-  Drain
-  Outlet for circulate pump
-  Fountain
-  Diamond-KJ-2
-  Diamond-KJ-2.5
-  Diamond-KJ-4R
-  Diamond-KJ-4
-  Diamond-KJ-5
-  Ozoner generator
-  Pillow
-  Filter Cartridge
-  Topside Panel

