

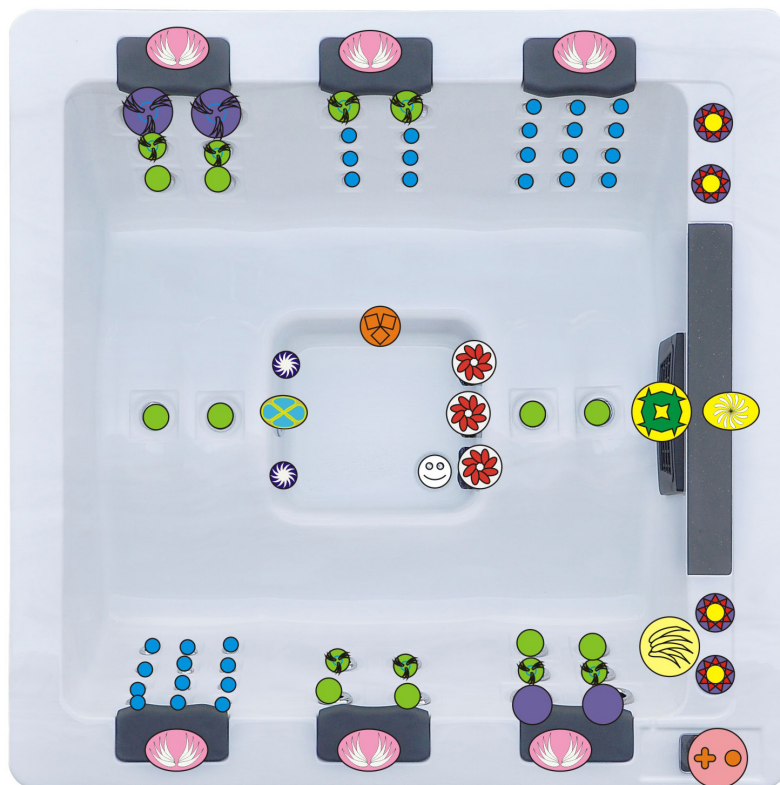





















BASTIDE

COLLECTION CONTEMPORAINE



- | | | | | | |
|---|---------------------------|---|-------------------------|---|---------|
|  | Air Valve |  | Air Jet |  | KJ-2.5 |
|  | Outlet for circulate pump |  | KJ-50# |  | KJ-4.5R |
|  | Big LED |  | KJ-3.5 | | |
|  | Ozoner mixer |  | KJ-3.5R | | |
|  | Drain |  | KJ-5 | | |
|  | Suction |  | KJ-5R | | |
|  | Diverter Valve |  | Waterfall-control Valve | | |
|  | Topside Panel |  | Fountain | | |
|  | Pillow |  | Cup Holder | | |
|  | Filter Cartridge |  | Waterfall | | |

BASTIDE

COLLECTION CONTEMPORAINE

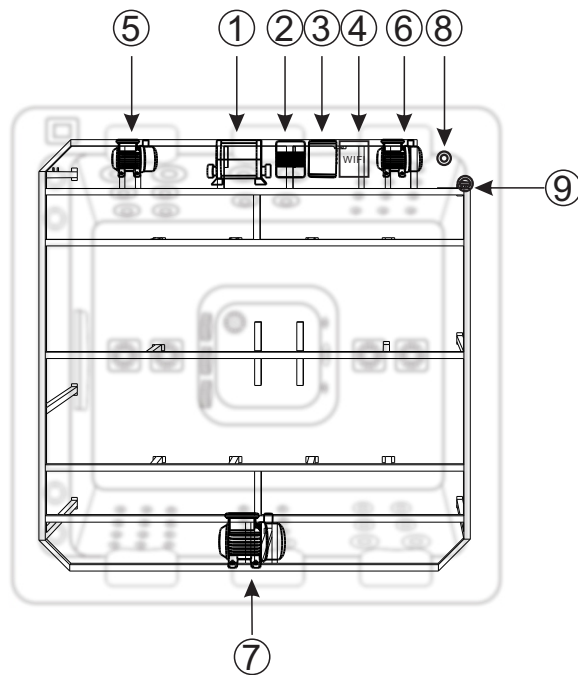
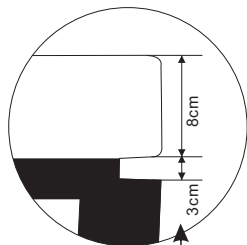
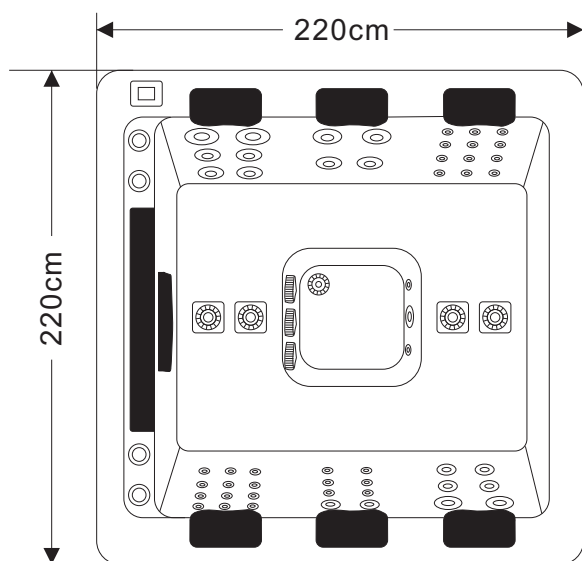

1	Balboa BP System
2	Ozoner Generator(KOZG-1)
3	LED Synchronizer(KLEDS-1)
4	WIFI Mould
5	LX Circulate Pump(DH1.0)
6	LX Whirlpool Pump1(WP-300II)
7	LX Whirlpool Pump2(WP-200II)
8	Cable
9	Drain