

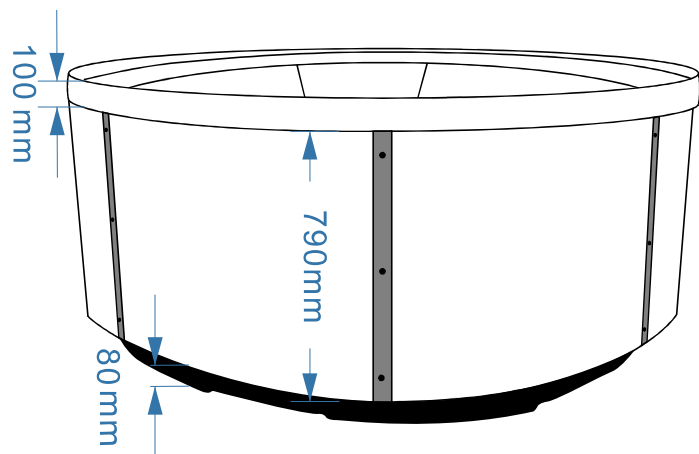

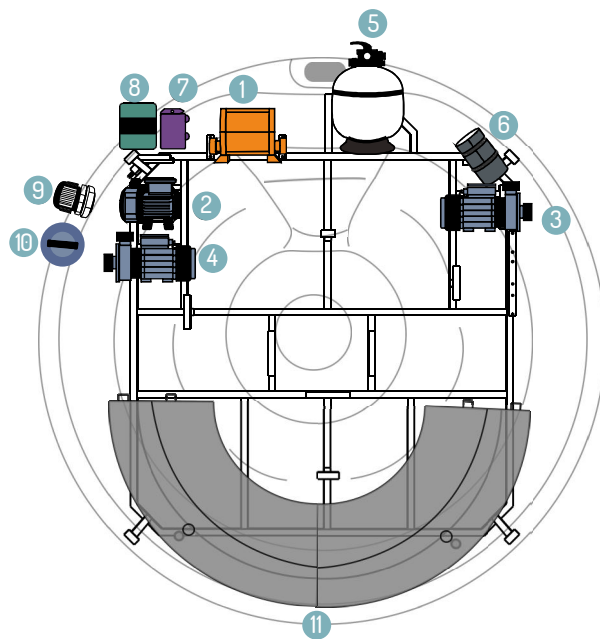

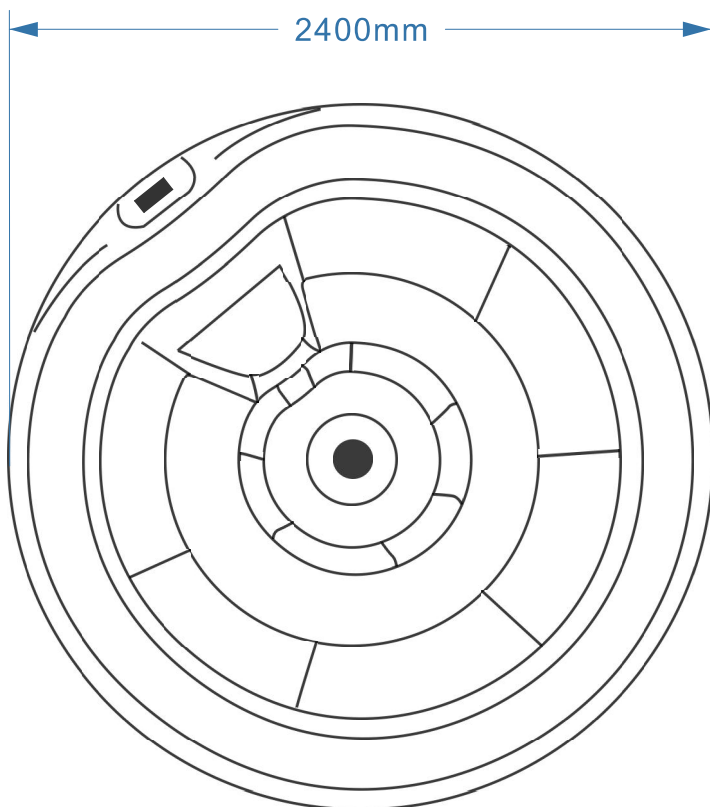







SARGOA

COLLECTION SPA À DÉBORDEMENT



| No. | Items | Part n° |
|-----|--|--------------------------------|
| ① |  | Controller |
| ② |  | SPA circulation pump(DH1.0) |
| ③ |  | Massage the water pump(LP200)1 |
| ④ |  | Massage the water pump(LP200)2 |
| ⑤ |  | Sand Filter |
| ⑥ |  | Air pump(AP400) |
| ⑦ |  | Synchronizer |
| ⑧ |  | Ozone |
| ⑨ |  | PG head |
| ⑩ |  | Drain water |
| ⑪ |  | Water storage tank(2pcs) |

SARGOA

COLLECTION SPA À DÉBORDEMENT

